



BERETTA

EXTRA



BERETTA

2022 FIREARMS CATALOG



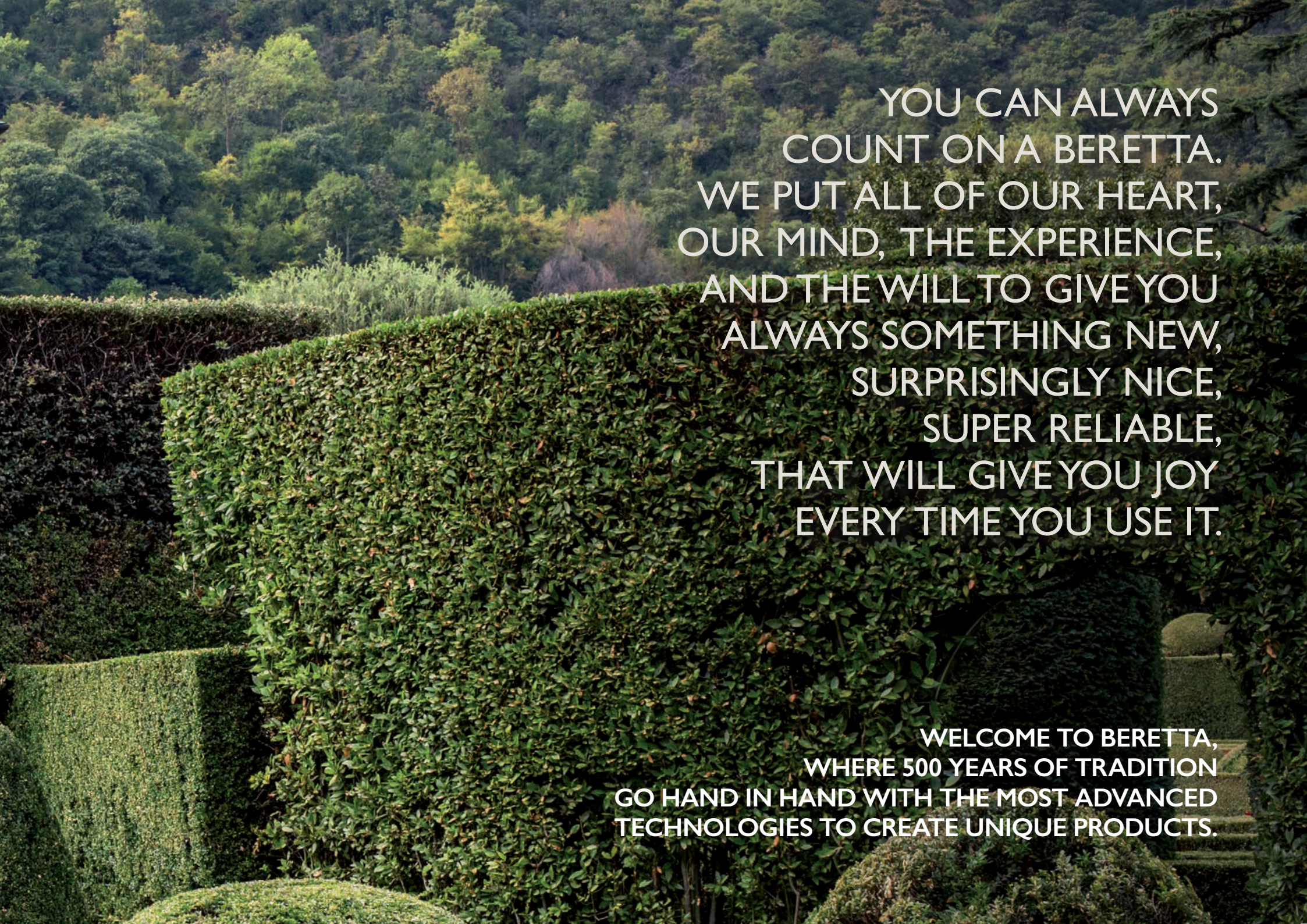

YOU CAN ALWAYS
COUNT ON A BERETTA.
WE PUT ALL OF OUR HEART,
OUR MIND, THE EXPERIENCE,
AND THE WILL TO GIVE YOU
ALWAYS SOMETHING NEW,
SURPRISINGLY NICE,
SUPER RELIABLE,
THAT WILL GIVE YOU JOY
EVERY TIME YOU USE IT.

WELCOME TO BERETTA,
WHERE 500 YEARS OF TRADITION
GO HAND IN HAND WITH THE MOST ADVANCED
TECHNOLOGIES TO CREATE UNIQUE PRODUCTS.

FOR SOME IT'S A GENTLEMEN'S HUNT,
FOR SOME IT'S HANGING OUT WITH BUDDIES.
FOR SOME IT'S A BIG FAMILY,
FOR SOME IT'S A JUST A CREW.
FOR SOME IT'S AN AFTER-WORK GROUP,
FOR SOME IT'S LIKE AN ALUMNI NETWORK.
FOR SOME IT'S BEING IMMERSED IN NATURE,
FOR SOME IT'S SAVORING ITS MOST AUTHENTIC TASTE.
FOR SOME IT'S A CLIQUE OF CONNOISSEURS,
FOR SOME IT'S A 1 MILLION CLICK COMMUNITY ON FACEBOOK.
FOR SOME IT'S A WOMAN THING,
FOR SOME IT'S A FATHER AND SON THING.

BUT ALL TOGETHER, THESE PEOPLE MAKE UP
THE LARGEST FAMILY OF HUNTERS THAT EVER EXISTED.
BECAUSE IT STRETCHES BACK 500 YEARS,
RIGHT TO THE START OF THE BERETTA DYNASTY.
...IT IS THE BERETTA TRIBE.

BE PART OF THE

#BERETTATRIBE





686 SILVER PIGEON I



686 Silver Pigeon I

The 686 Silver Pigeon I is Beretta's most popular over and under shotgun of all time. Based on the superb 680 platform, with its unmistakable low, slim action and legendary, ultra reliable mechanism; it won the hearts of shooting enthusiasts the world over.

The new version incorporates the perfect ballistics of Beretta's highly reputed Steelium Optima-Bore HP barrels. It also features a more defined and lustrous floral engraving, which is further enhanced with images of grapes on the vine and the iconic Beretta Three Arrows logo on both side of the action.

All of which combines to make the 686 Silver Pigeon I the most elegant, well-balanced and quick-to-shoulder, factory-made shotgun in the world.

| Model | Gauge | Chamber (mm) | Barrel (cm) | Rib (type) | Chokes (type) | Accessories | Drop (mm/mm) | Cast | Pad |
|---------------------------------------|---------|--------------|-------------|------------|---------------|-------------|--------------|-------|-------------|
| 686 Silver Pigeon I | 12 | 76 | 67-71-76 | 6x6 | OCHP | 5 Chokes | 36,5/57,5 | RH-LH | Extralight® |
| 686 Silver Pigeon I Vittoria | 12 | 76 | 67-71-76 | 6x6 | OCHP | 5 Chokes | 35/45/55 | RH-LH | Extralight® |
| 686 Silver Pigeon I (B-Fast) | 12 | 76 | 67-71-76 | 6x6 | OCHP | 5 Chokes | 38/60 | RH-LH | Extralight® |
| 686 Silver Pigeon I Vittoria (B-Fast) | 12 | 76 | 67-71-76 | 6x6 | OCHP | 5 Chokes | 35/45/55 | RH-LH | Extralight® |
| 686 Silver Pigeon I | 20 | 76 | 67-71-76 | 6x6 | OCHP | 5 Chokes | 36,5/57,5 | RH-LH | Extralight® |
| 686 Silver Pigeon I Vittoria | 20 | 76 | 67-71-76 | 6x6 | OCHP | 5 Chokes | 35/45/55 | RH-LH | Extralight® |
| 686 Silver Pigeon I | 28 | 70 | 67-71-76 | 6x6 | OCHP | 5 Chokes | 36,5/57,5 | RH-LH | Extralight® |
| 686 Silver Pigeon I | .410 | 76 | 67-71 | 6x6 | MC | 5 Chokes | 36,5/57,5 | RH-LH | Extralight® |
| 686 Silver Pigeon I Combo | 20/28 | 76/70 | 71 | 6x6 | MC | 5 Chokes | 36,5/57,5 | RH | Extralight® |
| 686 Silver Pigeon I Combo | 28/.410 | 70/76 | 71 | 6x6 | MC | 5 Chokes | 36,5/57,5 | RH | Extralight® |





687 SILVER PIGEON III



687 Silver Pigeon III

THE BEAUTY OF A PERFECT SHOT

The 687 Silver Pigeon III shotgun represents an elegant evolution of the Silver Pigeon I, designed for shooters looking for the reliability and minimal maintenance requirements of the 680 platform, presented with attractive aesthetics and a superior wood finish.

The fine game scene engraving is embellished by a special sparkle in the bas-relief areas for a pleasant contrast effect, while exquisite gloss finish enhances the grain of the stunning class 2.5 wood, protects it from rain and improves longevity. All these features are combined with the excellent ballistics guaranteed by the Steelium Optima-Bore HP tri-alloy steel barrels.

| Model | Gauge | Chamber (mm) | Barrel (cm) | Rib (type) | Chokes (type) | Accessories | Drop (mm/mm) | Cast | Pad |
|---|-------|--------------|-------------|------------|---------------|-------------|---------------|-------|------------|
| 687 Silver Pigeon III | 12 | 76 | 67-71-76 | 6x6 | OCHP | 5 Chokes | 35/55 - 38/60 | RH-LH | MicroCore® |
| 687 Silver Pigeon III Vittoria | 12 | 76 | 67-71-76 | 6x6 | OCHP | 5 Chokes | 35/45/55 | RH-LH | MicroCore® |
| 687 Silver Pigeon III (B-Fast) | 12 | 76 | 67-71-76 | 6x6 | OCHP | 5 Chokes | 38/60 | RH-LH | MicroCore® |
| 687 Silver Pigeon III Vittoria (B-Fast) | 12 | 76 | 67-71-76 | 6x6 | OCHP | 5 Chokes | 35/45/55 | RH-LH | MicroCore® |
| 687 Silver Pigeon III | 20 | 76 | 67-71-76 | 6x6 | OCHP | 5 Chokes | 35/55 - 38/60 | RH-LH | MicroCore® |
| 687 Silver Pigeon III Vittoria | 20 | 76 | 67-71-76 | 6x6 | OCHP | 5 Chokes | 35/45/55 | RH-LH | MicroCore® |
| 687 Silver Pigeon III | 28 | 76 | 67-71-76 | 6x6 | OCHP | 5 Chokes | 35/55 - 38/60 | RH-LH | MicroCore® |
| 687 Silver Pigeon III | .410 | 76 | 67-71-76 | 6x6 | OCHP | 5 Chokes | 35/55 - 38/60 | RH-LH | MicroCore® |

Ultraleggero



EXTRALIGHT® RECOIL PAD

- 30% lighter than a standard recoil pad
- Much more resistant to abrasion, aging and the elements
- Closed cell structure that avoids liquid absorption
- Delivering comfort, stability and excellent recoil absorption

| Model | Gauge | Chamber (mm) | Barrel (cm) | Rib (type) | Chokes (type) | Accessories | Drop (mm/mm) | Cast | Pad |
|--|-------|--------------|-------------------|------------|---------------|-------------|--------------|-------|-------------|
| Ultraleggero | 12 | 76 | 61 - 66 - 71 - 76 | 6x6 | OCHP | 5 Chokes | 35/55 | RH-LH | Extralight® |
| Ultraleggero - double single selective trigger | 12 | 76 | 66 - 71 | 6x6 | OCHP | 5 Chokes | 35/55 | RH-LH | Extralight® |
| Ultraleggero Vittoria | 12 | 76 | 61-66-71-76 | 6x6 | OCHP | 5 Chokes | 35/45/55 | RH-LH | Extralight® |



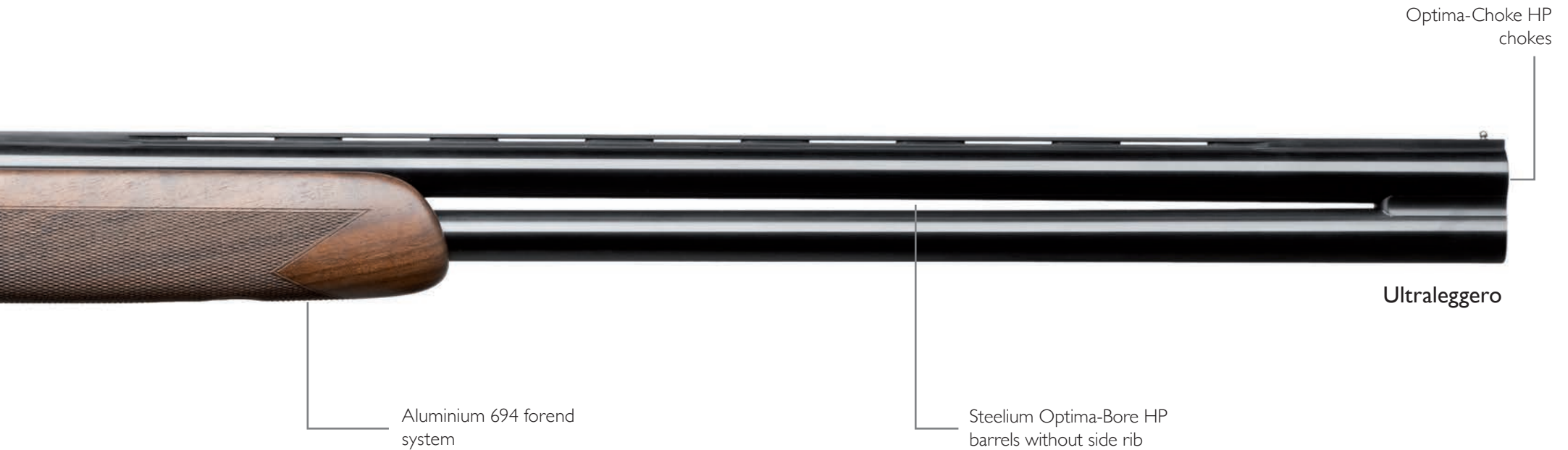

WEIGHT
2,8 KG
(with 61 cm
barrel)

The Ultraleggero begins a whole new chapter in the history of lightweight over and under shotguns, pushing the boundaries of design beyond all previous imagination; delivering the strength and reliability of a steel receiver but with an exceptionally low weight, something that had only previously been achieved with aluminium receivers. Thanks to the use of state-of-the-art engineering techniques,

Beretta “skeletonised” the receiver and reduced weight in several components of the shotgun, including only the structural elements that are essential for the rigidity, the performance and the balance of this shotgun. The result is a lightweight yet sturdy shotgun, ideal for hunters looking for a fast-handling gun that swiftly gets onto the game.

Enjoy your hunt, gun weight will no longer be a burden.

STRENGTH MADE LIGHT

687 EELL Diamond Pigeon



687 EELL Diamond Pigeon Game scene



687 EELL Diamond Pigeon Scroll

The exceptionally strong, low-profile receiver is elegantly adorned with exquisite game scene or intricate scroll engravings, made with the best in class premium laser engraving technology. The stock and forend are superior quality walnut embellished with hand cut chequering and lustrous gloss finish, demonstrating how improved performance and refined beauty can be perfectly matched.

| Model | Gauge | Chamber (mm) | Barrel (cm) | Rib (type) | Chokes (type) | Accessories | Drop (mm/mm) | Cast | Pad |
|-------------------------|--------|--------------|-------------|------------|----------------|-------------|---------------|-------|------|
| 687 EELL Diamond Pigeon | 12 | 76 | 67-71-76 | 6x6 | OCHP | 5 Chokes | 35/55 - 38/60 | RH-LH | Wood |
| 687 EELL Diamond Pigeon | 12 | 76 | 71-76 | 6x6 | FX (****/****) | - | 35/55 - 38/60 | RH-LH | Wood |
| 687 EELL Diamond Pigeon | 20 | 76 | 67-71-76 | 6x6 | OCHP | 5 Chokes | 35/55 - 38/60 | RH-LH | Wood |
| 687 EELL Diamond Pigeon | 20 | 76 | 71-76 | 6x6 | FX (****/****) | - | 35/55 - 38/60 | RH-LH | Wood |
| 687 EELL Diamond Pigeon | 28 | 70 | 67-71-76 | 6x6 | OCHP | 5 Chokes | 35/55 - 38/60 | RH | Wood |
| 687 EELL Diamond Pigeon | .410 | 76 | 67-71 | 6x6 | MC | 5 Chokes | 35/55 - 38/60 | RH | Wood |
| 687 EELL Diamond Pigeon | 20/28 | 76/70 | 67-71 | 6x6 | HP | 5x2 Chokes | 35/55 - 38/60 | RH | Wood |
| 687 EELL Diamond Pigeon | 28/410 | 70/76 | 67-71 | 6x6 | HP/MC | 5x2 Chokes | 35/55 - 38/60 | RH | Wood |

486 *Parallelo*



Built with a beautifully proportioned, scroll engraved, round body receiver, the 486 is a modern classic in the making. Using a modified demi-block design, Beretta's 'Triblock' system allows for a seamless barrel profile in the best English tradition whilst the V spring mechanism ensures fast, crisp trigger pulls.

| Model | Gauge | Chamber (mm) | Barrel (cm) | Rib (type) | Chokes (type) | Accessories | Drop (mm/mm) | Cast | Pad |
|-------------------|-------|--------------|-------------|------------|----------------------------|-------------|--------------|------|------|
| 486 | 12 | 76 | 66-71-76 | 10x5,5 | OCHP | 5 Chokes | 37/59 | RH | Wood |
| 486 | 12 | 76 | 71 | 10x5,5 | FX (***/*), FX (****/****) | - | 37/59 | RH | Wood |
| 486 | 12 | 76 | 76 | 10x5,5 | FX (****/****) | - | 37/59 | RH | Wood |
| 486 | 20 | 76 | 66-71-76 | 10x5,5 | OCHP | 5 Chokes | 37/59 | RH | Wood |
| 486 | 28 | 70 | 71 | 10x5,5 | OCHP | 5 Chokes | 37/59 | RH | Wood |
| 486 EL | 20 | 76 | 66-71-76 | 10x5,5 | OCHP | 5 Chokes | 37/59 | RH | Wood |
| 486 EL Color Case | 20 | 76 | 66-71-76 | 10x5,5 | OCHP | 5 Chokes | 37/59 | RH | Wood |

686 Silver Pigeon I Vittoria

687 Silver Pigeon III Vittoria (B-Fast)

| Model | Gauge | Chamber (mm) | Barrel (cm) | Rib (type) | Chokes (type) | Accessories | Drop (mm/mm) | Cast | Pad |
|---|-------|--------------|-------------|------------|---------------|-------------|--------------|-------|-------------|
| 686 Silver Pigeon I Vittoria | 12 | 76 | 67-71-76 | 6x6 | OCHP | 5 Chokes | 35/45/55 | RH-LH | Extralight® |
| 686 Silver Pigeon I Vittoria (B-Fast) | 12 | 76 | 67-71-76 | 6x6 | OCHP | 5 Chokes | 35/45/55 | RH-LH | Extralight® |
| 686 Silver Pigeon I Vittoria | 20 | 76 | 67-71-76 | 6x6 | OCHP | 5 Chokes | 35/45/55 | RH-LH | Extralight® |
| 687 Silver Pigeon III Vittoria | 12 | 76 | 67-71-76 | 6x6 | OCHP | 5 Chokes | 35/45/55 | RH-LH | MicroCore® |
| 687 Silver Pigeon III Vittoria (B-Fast) | 12 | 76 | 67-71-76 | 6x6 | OCHP | 5 Chokes | 35/45/55 | RH-LH | MicroCore® |
| 687 Silver Pigeon III Vittoria | 20 | 76 | 67-71-76 | 6x6 | OCHP | 5 Chokes | 35/45/55 | RH-LH | MicroCore® |



Ultraleggero Vittoria

The Vittoria series is the first Beretta's shotgun range specifically designed for women. Vittoria shotguns feature a dedicated ergonomics, suited to those with a shorter stature, to ensure a smooth, comfortable and precise handling. These guns are fitted with a shortened, semi-Montecarlo style stock, have a reduced pistol grip and additionally are completed by a 1 mm checkering, derived from the premium guns, beneficial for smaller hands.

| Model | Gauge | Chamber (mm) | Barrel (cm) | Rib (type) | Chokes (type) | Accessories | Drop (mm/mm) | Cast | Pad |
|-----------------------|-------|--------------|-------------|------------|---------------|-------------|--------------|-------|-------------|
| Ultraleggero Vittoria | 12 | 76 | 61-66-71-76 | 6x6 | OCHP | 5 Chokes | 35/45/55 | RH-LH | Extralight® |



THE 9 REASONS TO CHOOSE THE BERETTA SEMI-AUTO TECHNOLOGY

1 PERFECT PATTERNS ON EVERY SHOT.
The ingredients of the great accuracy of the Beretta Steelium barrels are: the exclusive tri-alloy Beretta Steel (Ni, Cr, Mo), the deep drilling, the cold hammer forging process and the vacuum distension. Every Optima-Bore HP barrel profile has been specifically designed and tested to provide perfect accuracy with every type of shells: lead, steel and steel High Performance.

4 ALL-LOAD PROVEN RELIABILITY, FROM 24 G. TO 64 G.
Beretta gas-operating system B-Link is world's most reliable system. The closing force is stronger because, when the reloading cycle begins, the energy available to unlock the bolt is significantly higher. Higher energy when opening allows higher closing force, preventing the bolt to unlock when it is not supposed to do it.

7 LOWEST MUZZLE JUMP.
Beretta semi-auto shotguns give you the lowest muzzle jump ever combining the stunning recoil reduction of the Kick-Off devices with the unique ballistic features of the Steelium Optima-Bore HP barrels. More control after each shot, better performance for each next one.

2 THE BEST RECOIL REDUCTION.
Kick-Off, Kick-Off Plus and Kick-Off Mega ensure you up to 70% recoil reduction giving you more stability, comfort and control for faster target acquisition. More comfort for you, especially when you enjoy shooting hundreds of shots in a single day, and enhanced durability.

5 COMFORT AND EASY TO ASSEMBLE.
The Extralight® recoil pad is 30% lighter than a standard recoil pad and much more resistant to abrasion, aging and the elements. Its closed cell structure avoids liquid absorption and its structure delivers comfort, stability and excellent recoil absorption. The B-Lok cap, the magazine cap exclusive to Beretta, ensures a perfect and secure closing with just 60 degrees of rotation instead of multiple turns.

8 ERGONOMIC AND EASY TO OPERATE.
The extended bolt handle and bolt release low profile lever allow for easier manipulation during the coldest and rainiest days. An enlarged loading port facilitates an easier and quicker reloading. The new extended lifter avoids thumb bite or glove catch while loading the gun.

3 UNBELIEVABLE RELOADING SPEED (+36%).
The Beretta gas-operated system is fast like an eye's blink. That's why it's called B-Link. The power of the gas-system, combined with the precision of the rotating bolt, ensure you a fast, reliable and smart cycling. You can spend all your magazine's cartridges before the 1st round touches the ground.

6 CLEANER THAN EVER AND EASIER TO CLEAN.
With B-Link, the only weak point of the gas-operating system has been practically reduced to zero. The re-engineering of gas ports and the systematic reduction of all the mechanical frictions reduce dirt to the minimum terms. You will experience the lowest maintenance need ever, and a smart, easy, fast and secure cleaning.

9 DESIGNED FOR THE FUTURE, NEVER FORGETTING TRADITION.
The Beretta in-house design team works every day to match design with functionality, giving you original and aesthetically beautiful, simple solutions that optimize the shape, weight and ease of use.

A300 Outlander



A300 Outlander Silver

A300 Outlander

The A300 Outlander is the latest evolution of Beretta's A300-series gas-operated semi-auto shotguns, which have been sold to millions of hunters and sportsmen around the world. And there's a reason for their popularity: unbeatable performance as well as great value out of the box.

| Model | Gauge | Chamber (mm) | Barrel (cm) | Rib (type) | Chokes (type) | Accessories | Pad |
|----------------------------|-------|--------------|-------------|------------|---------------|------------------------|-------------|
| A300 Outlander Silver | 12 | 76 | 66-71-76 | 6x6 | MC | 3 Chokes (*/***/*****) | Extralight® |
| A300 Outlander | 12 | 76 | 66-71-76 | 6x6 | MC | 3 Chokes (*/***/*****) | Extralight® |
| A300 Outlander Camo MAX-5® | 12 | 76 | 66-71-76 | 6x6 | MC | 3 Chokes (*/***/*****) | Extralight® |
| A300 Outlander Synthetic | 12 | 76 | 66-71-76 | 6x6 | MC | 3 Chokes (*/***/*****) | Extralight® |



A400 Lite Synthetic



A400 Lite Camo MAX-5®

The Beretta A400 Lite is a hunting shotgun that does it all, and that doesn't mind playing hard and getting dirty. It's a 3" semi-auto shotgun combining the Kick-Off Plus shock absorption, the unrivalled Beretta Steelium barrels and a great package of smart, lightweight polymeric solutions. Fast, versatile, light and low-recoiling, the A400 Lite is also self-cleaning, requiring much less maintenance than you can expect.

| Model | Gauge | Chamber (mm) | Barrel (cm) | Rib (type) | Chokes (type) | Accessories | Pad |
|---------------------------------|-------|--------------|-------------|------------|---------------|------------------------|-------------|
| A400 Lite Synthetic | 12 | 76 | 66-71-76 | 6x6 | OCHP | 3 Chokes (*/***/*****) | Extralight® |
| A400 Lite Synthetic Left Handed | 12 | 76 | 66-71-76 | 6x6 | OCHP | 3 Chokes (*/***/*****) | Extralight® |
| A400 Lite Synthetic | 20 | 76 | 66-71-76 | 6x6 | OCHP | 3 Chokes (*/***/*****) | Extralight® |
| A400 Lite Camo MAX-5® | 12 | 76 | 66-71-76 | 6x6 | OCHP | 3 Chokes (*/***/*****) | Extralight® |
| A400 Lite Camo MAX-5® | 20 | 76 | 66-71-76 | 6x6 | OCHP | 3 Chokes (*/***/*****) | Extralight® |



A400 Xplor ACTION



A400 Xplor Action

Shoot everything, every time, better.
Beautiful, versatile, lightweight and intelligent. Available in 12 gauge – also left handed – and in 20 and 28,
the A400 Xplor Action is the perfect semi-automatic shotgun for all your upland hunts.
A400 Xplor Action is also available for left-handed shooters and with the Kick-Off system, reducing muzzle rise and recoil up to 60%.

| Model | Gauge | Chamber (mm) | Barrel (cm) | Rib (type) | Chokes (type) | Accessories | Pad |
|--|-------|--------------|-------------|------------|---------------|------------------------|-------------|
| A400 Xplor Action | 12 | 76 | 66-71-76 | 6x6 | OCHP | 3 Chokes (*/***/*****) | Extralight® |
| A400 Xplor Action | 20 | 76 | 66-71-76 | 6x6 | OCHP | 3 Chokes (*/***/*****) | Extralight® |
| A400 Xplor Action | 28 | 70 | 66-71-76 | 5x5 | OCHP | 3 Chokes (*/***/*****) | Extralight® |
| A400 Xplor Action Left-Handed | 12 | 76 | 66-71-76 | 6x6 | OCHP | 3 Chokes (*/***/*****) | Extralight® |
| A400 Xplor Action Kick-Off | 12 | 76 | 66-71-76 | 6x6 | OCHP | 3 Chokes (*/***/*****) | Extralight® |
| A400 Xplor Action Left-Handed Kick-Off | 12 | 76 | 66-71-76 | 6x6 | OCHP | 3 Chokes (*/***/*****) | Extralight® |
| A400 Xplor Action Slug | 12 | 76 | 56-61 | - | FX (*****) | - | Extralight® |
| A400 Xplor Action Kick-Off Slug | 12 | 76 | 56-61 | - | FX (*****) | - | Extralight® |

A400
ultra LITE



A400 Ultralite

Much more than light, Ultralite.
The 3" semi-auto shotgun with full-length carbon fiber top rib and carbon fiber pistol grip cap, bringing weight down to 2,7 Kg without shortening the magazine capacity.
Black anodized aluminium-alloy receiver with technological laser engraving and super-lightweight woods.
Simply amazing.

| Model | Gauge | Chamber (mm) | Barrel (cm) | Rib (type) | Chokes (type) | Accessories | Pad |
|----------------|-------|--------------|-------------|------------------|---------------|----------------------|-------------|
| A400 Ultralite | 12 | 76 | 61-66-71 | 6x6 Carbon fiber | OCHP | 3 Chokes (*/**/****) | Extralight® |

A400 Upland



A400 Upland



A400 Upland Kick-Off Plus

The A400 Upland is the very first Beretta shotgun featuring an innovative wood stock with the Kick-Off Plus technology, that reduces recoil up to 40%. The nickel plated receiver is completed by an exquisite game scene engraving.

The new design of the pistol grip and forend improves the gun comfort and enhances the overall look.

The A400 Upland is a great combination of the latest technologies with a classic look, for all the hunters that are looking for the best shooting experience.

| Model | Gauge | Chamber (mm) | Barrel (cm) | Rib (type) | Chokes (type) | Accessories | Pad |
|---------------------------|-------|--------------|-------------|------------|---------------|------------------------|-------------|
| A400 Upland Kick-Off Plus | 12 | 76 | 66-71-76 | 6x6 | OCHP | 3 Chokes (*/***/*****) | Extralight® |
| A400 Upland | 12 | 76 | 66-71-76 | 6x6 | OCHP | 3 Chokes (*/***/*****) | Extralight® |
| A400 Upland Kick-Off Plus | 20 | 76 | 66-71-76 | 6x6 | OCHP | 3 Chokes (*/***/*****) | Extralight® |
| A400 Upland | 20 | 76 | 66-71-76 | 6x6 | OCHP | 3 Chokes (*/***/*****) | Extralight® |





A400 Xtreme PLUS



| Model | Gauge | Chamber (mm) | Barrel (cm) | Rib (type) | Chokes (type) | Accessories | Pad |
|--|-------|--------------|-------------|------------|---------------|--|-------------|
| A400 Xtreme Plus Synthetic | 12 | 89 | 66-71-76 | 7x7 | OCHP | 5 Chokes Ext. Black Edition (*/**/*****/***) | Extralight® |
| A400 Xtreme Plus Camo MAX-5® | 12 | 89 | 66-71-76 | 7x7 | OCHP | 5 Chokes Ext. Black Edition (*/**/*****/***) | Extralight® |
| A400 Xtreme Plus Camo Mossy Oak Bottomland | 12 | 89 | 66-71-76 | 7x7 | OCHP | 5 Chokes Ext. Black Edition (*/**/*****/***) | Extralight® |
| A400 Xtreme Plus Camo Shadow Grass Blades | 12 | 89 | 66-71-76 | 7x7 | OCHP | 5 Chokes Ext. Black Edition (*/**/*****/***) | Extralight® |
| A400 Xtreme Plus Camo True Timber DRT | 12 | 89 | 66-71-76 | 7x7 | OCHP | 5 Chokes Ext. Black Edition (*/**/*****/***) | Extralight® |
| A400 Xtreme Plus Camo Optifade™ Marsh | 12 | 89 | 66-71-76 | 7x7 | OCHP | 5 Chokes Ext. Black Edition (*/**/*****/***) | Extralight® |
| A400 Xtreme Plus Camo Optifade™ Timber | 12 | 89 | 66-71-76 | 7x7 | OCHP | 5 Chokes Ext. Black Edition (*/**/*****/***) | Extralight® |
| A400 Xtreme Plus Prairie True Timber DRT | 12 | 89 | 66-71-76 | 7x7 | OCHP | 5 Chokes Ext. Black Edition (*/**/*****/***) | Extralight® |
| A400 Xtreme Plus Camo Veil Avayde | 12 | 89 | 66-71-76 | 7x7 | OCHP | 5 Chokes Ext. Black Edition (*/**/*****/***) | Extralight® |

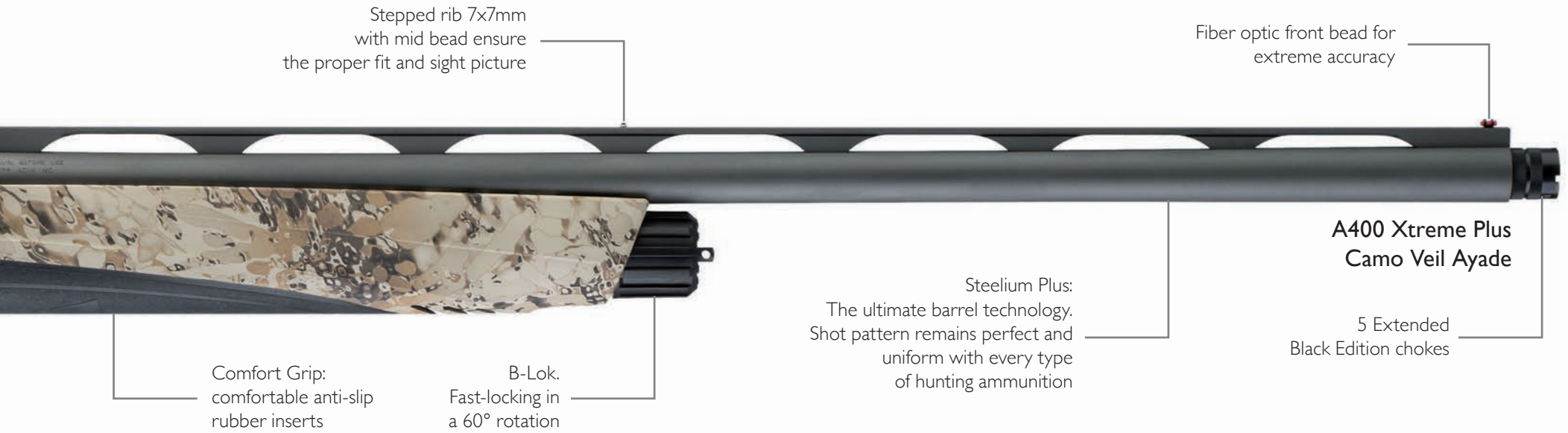

Stepped rib 7x7mm
with mid bead ensure
the proper fit and sight picture

Fiber optic front bead for
extreme accuracy

**A400 Xtreme Plus
Camo Veil Ayade**

5 Extended
Black Edition chokes

Steelium Plus:
The ultimate barrel technology.
Shot pattern remains perfect and
uniform with every type
of hunting ammunition

Comfort Grip:
comfortable anti-slip
rubber inserts

B-Lok.
Fast-locking in
a 60° rotation



Mossy Oak
Bottomland



Shadow Grass
Blades

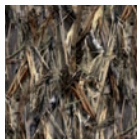

True Timber
DRT



Optifade™ Marsh

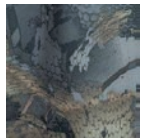

Optifade™
Timber

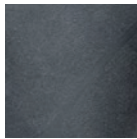

Synthetic

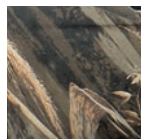

Camo MAX-5®

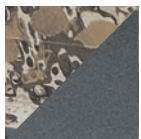

Camo Veil
Avayde

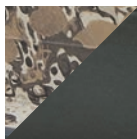

Prairie True
Timber DRT

Xtreme preparations, Xtreme conditions, Xtreme expectations.
The new A400 Xtreme Plus is built to go wherever your hunt takes you. Engineered to be the softest-shooting, most reliable 3.5" waterfowl shotgun out there, and to withstand the toughest waterfowl environments.

It has the best recoil and muzzle rise reduction system in the world: the Kick-Off Mega, combining 3 hydraulic shock-absorbers and return springs to reduce recoil up to 70% and the B-Steady system, avoiding the annoying sliding of the nose piece on the cheek, to let your face perfectly firm on the stock and never lose the line of sight.

It features Beretta's exclusive Steelium Plus barrels, providing the best possible patterning from all hunting loads. An extended charging handle and bolt release from the factory allow for easier manipulation during the coldest and rainiest days. An enlarged loading port allows for ease of loading.

The new A400 Xtreme Plus shoots always, shoots everything and shoots even better!

BRX1

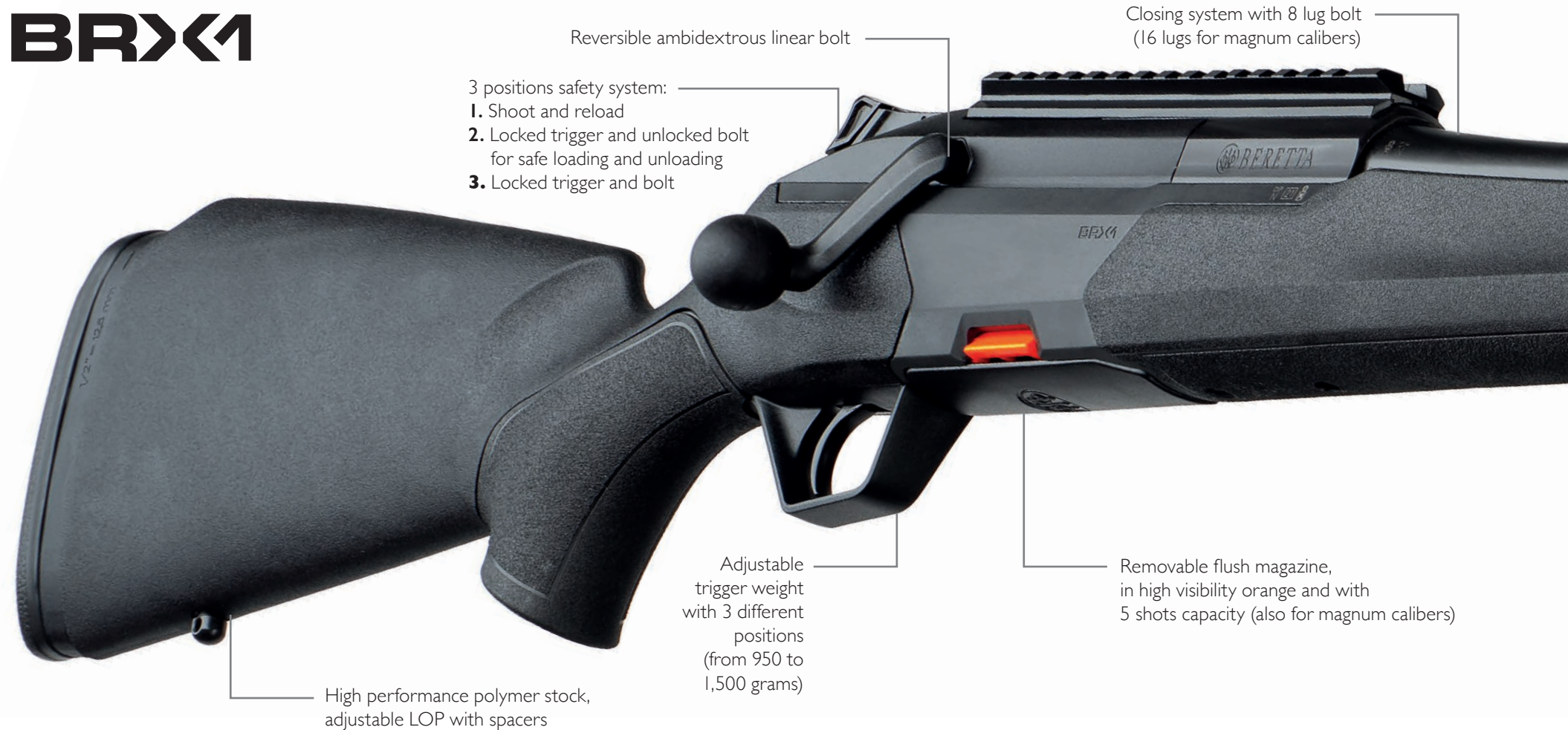

| Model | Gauge | Stock | Magazine capacity | Receiver | Barrel (type) | Barrel length (cm) | Barrel profile (mm) | Muzzle thread (mm) | Twist rate | Recoil pad |
|-------|-------------|-----------------|-------------------|-------------------------|------------------------|--------------------|---------------------|--------------------|------------|-------------|
| BRX1 | 308 | Synthetic black | 5 | Black anodized aluminum | Blued - no iron sights | 51-57 | 16mm | 14mm | 1-11" | Extralight® |
| BRX1 | 30.06 Spr. | Synthetic black | 5 | Black anodized aluminum | Blued - no iron sights | 51-57 | 16mm | 14mm | 1-11" | Extralight® |
| BRX1 | 300 Win Mag | Synthetic black | 5 | Black anodized aluminum | Blued - no iron sights | 62 | 16mm | 14mm | 1-11" | Extralight® |

BRX1

Interchangeable barrels of different calibers



BRX1

M14 threaded barrel with thread cover for 16 mm barrel profile

High performance polymer forend with two textured grips

LOAD YOUR INSTINCT

Beretta is stepping into the world of hunting rifles, offering a revolutionary firearm with a linear reloading system. This new rifle encapsulates all of Beretta's experience, acquired over years of working in both the military and commercial market. The BRX1 guarantees the utmost speed, accuracy, precision, safety and ease of use, from the first pull of the trigger to the reload. The smoothness of reloading, the interchangeable barrels of varying calibers, three trigger weight options, fully ambidextrous bolt and extraction side with the possibility to change from right hand to left without any tools make the BRX1 a versatile, modern, modular firearm suitable for every kind of hunter and shooting environment.

HUNTING Rifle





Pads and spacers



Magazines



Bolt knobs



Cheek protectors



Rails, mounts and rings



Muzzle threads



Merchandise



Stocks and forends



Slings



Cleaning kits



Hard and soft cases



Beretta BRX1 comes with a wide range of accessories to take your hunting experience to its full potential. Complete your rifle with Beretta products and live your passion to the fullest.

EVERY BIG WIN IS MADE OF SMALL VICTORIES

Behind every smashed target there is a wealth of details that have been studied and developed with the world's no. 1 shooters. So, every detail of your firearm, clothing, and accessories will really make a difference the next time you step onto the shooting field. Tag your passion for shooting with #1CHOICEOFCHAMPIONS



**THE N^o1 CHOICE
OF CHAMPIONS**



Hand fitting by Beretta Premium Gunsmiths

Factory Balance

Interchangeable Barrel Shoulders

Hand-engraved anti-glare finishing

B-Fast Balance

Protection against the sun reflection

Inner sweatband

High grade selected walnut stock

Perfectly adjustable

Maximum perception during the shoot

Designed on the shooter's movements

Reduced felt recoil

Technical fabric

MicroCore® recoil pad

Fast and precise shouldering

Easy customizable

Reduced muzzle rise

Barrell accuracy 100% tested

Steelium Pro barrel

Cold hammer forging

Proprietary tri alloyed steel

Improved pattern distribution

Smoother swing

Modified single base rib for better heat dissipation

Center-mass low and coaxial

18 inches forcing cone

Vacuum distension

Wide receiver Deep drilling

Detachable trigger group

V-spring trigger group

Adjustable trigger

No itch

Extremely breathable

Protection, perception and freedom

Excellent breathability

Badge chest

Perfect fit

Earmuff/towel binding on both sides

686 SILVER PIGEON I Sporting



686 Silver Pigeon I Sporting (B-Fast)

The Beretta's most popular over and under shotgun of all time. Based on the superb 680 platform, with its unmistakable low, slim action and legendary, ultra reliable mechanism; it won the hearts of shooting enthusiasts the world over. The new version incorporates the perfect ballistics of Beretta's highly reputed Steelium Optima-Bore HP barrels. It also features a more defined and lustrous floral engraving, which is further enhanced with images of grapes on the vine and the iconic Beretta Trident logo on both side of the action. All of which combines to make the 686 Silver Pigeon I the most elegant, well-balanced and quick-to-shoulder, factory-made shotgun in the world.

| Model | Gauge | Chamber (mm) | Barrel (cm) | Rib (type) | Chokes (type) | Accessories | Drop (mm/mm) | Cast | Forend |
|--|-------|--------------|-------------|------------|---------------|-------------|--------------|-------|-----------------|
| 686 Silver Pigeon I Sporting | 12 | 76 | 71-76-81 | 10x8 | OCHP | 5 Chokes | 36,5/57,5 | RH-LH | Schnabel |
| 686 Silver Pigeon I Sporting Vittoria | 12 | 76 | 71-76-81 | 10x8 | OCHP | 5 Chokes | 35/45/55 | RH-LH | Schnabel |
| 686 Silver Pigeon I Sporting (B-Fast) | 12 | 76 | 76 | 10x8 | OCHP | 5 Chokes | - | RH-LH | Schnabel |
| 686 Silver Pigeon I Sporting Vittoria (B-Fast) | 12 | 76 | 76 | 10x8 | OCHP | 5 Chokes | 35/45/55 | RH-LH | Schnabel |
| 686 Silver Pigeon I Sporting (B-Fast) | 20 | 76 | 76 | 8x8 | OCHP | 5 Chokes | - | RH-LH | Schnabel |
| 686 Silver Pigeon I Sporting Vittoria | 20 | 76 | 76 | 8x8 | OCHP | 5 Chokes | 35/45/55 | RH-LH | Schnabel |
| 686 Silver Pigeon I Sporting (B-Fast) | 28 | 70 | 76 | 8x8 | OCHP | 5 Chokes | - | RH-LH | Half Beavertail |
| 686 Silver Pigeon I Sporting (B-Fast) | .410 | 76 | 76 | 8x8 | MC | 5 Chokes | - | RH-LH | Half Beavertail |



687 SILVER PIGEON III Sporting



687 Silver Pigeon III Sporting

THE BEAUTY OF A PERFECT SHOT

The 687 Silver Pigeon III shotgun represents an elegant evolution of the Silver Pigeon I, designed for shooters looking for the reliability and minimal maintenance requirements of the 680 platform, presented with attractive aesthetics and a superior wood finish.

The fine game scene engraving is embellished by a special sparkle in the bas-relief areas for a pleasant contrast effect, while exquisite gloss finish enhances the grain of the stunning class 2.5 wood, protects it from rain and improves longevity. All these features are combined with the excellent ballistics guaranteed by the Steelium Optima-Bore HP tri-alloy steel barrels.

| Model | Gauge | Chamber (mm) | Barrel (cm) | Rib (type) | Chokes (type) | Accessories | Drop (mm/mm) | Cast | Forend |
|--|-------|--------------|-------------|------------|---------------|-------------|---------------|-------|----------|
| 687 Silver Pigeon III Sporting | 12 | 76 | 71-76-81 | 10x8 | OCHP | 5 Chokes | 35/55 - 38/60 | RH-LH | Schnabel |
| 687 Silver Pigeon III Sporting (B-Fast) | 12 | 76 | 71-76-81 | 10x8 | OCHP | 5 Chokes | 38/60 | RH-LH | Schnabel |
| 687 Silver Pigeon III Sporting Vittoria (B-Fast) | 12 | 76 | 71-76-81 | 10x8 | OCHP | 5 Chokes | 35/45/55 | RH-LH | Schnabel |
| 687 Silver Pigeon III Sporting | 20 | 76 | 76 | 8x8 | OCHP | 5 Chokes | 35/55 - 38/60 | RH-LH | Schnabel |
| 687 Silver Pigeon III Sporting (B-Fast) | 20 | 76 | 76 | 8x8 | OCHP | 5 Chokes | 38/60 | RH-LH | Schnabel |
| 687 Silver Pigeon III Sporting Vittoria (B-Fast) | 20 | 76 | 76 | 8x8 | OCHP | 5 Chokes | 35/45/55 | RH-LH | Schnabel |



694



694 Sporting



694 Trap



694 DTL Step Rib

694 is the over and under platform designed specifically for clay shooting, and with a precise objective in mind: to help shooters increase their success rate. Thanks to a meticulous mechanical and ergonomic design process, the 694 is perfectly balanced, natural and immediate when shouldering. The shape of the action and the stock provide increased field of vision, while the new forend iron system allows to maintain the opening load constant over time, and the Steelium Plus barrels guarantee a dense, uniform pattern every time. In addition to the Sporting and Trap version, the 694 is available also in Skeet, Down-The-Line, ACS (with adjustable top rib), Vittoria and Pro version (with adjustable TSK stock).

694



694 Pro

694 ACS

| Model | Gauge | Chamber (mm) | Barrel (cm) | Rib (type) | Chokes (type) | Accessories | Drop (mm/mm) | Cast | Forend |
|--------------------------------|-------|--------------|-------------|-----------------|---------------|--------------------|---------------|-------|--------------------|
| 694 Sporting | 12 | 76 | 71-76-79-81 | 10x8 | OCHP | 5 chokes | 35/50 - 35/55 | RH-LH | Schnabel-Rounded |
| 694 Sporting (B-Fast) | 12 | 76 | 71-76-79-81 | 10x8 | OCHP | 5 chokes | 35/55 | RH-LH | Schnabel-Rounded |
| 694 Sporting Vittoria (B-Fast) | 12 | 76 | 71-76-81 | 10x8 | OCHP | 5 Chokes, Extended | 35/45/55 | RH-LH | Schnabel-Rounded |
| 694 Trap | 12 | 70 | 76-81 | 10x10 | FX(**/*) | - | 35/45 - 29/39 | RH-LH | Beavertail-Rounded |
| 694 Trap (B-Fast) | 12 | 70 | 76-81 | 10x10 | FX(**/*) | - | 35/45 | RH-LH | Beavertail-Rounded |
| 694 Trap Vittoria (B-Fast) | 12 | 76 | 76-81 | 10x10 | FX (**/*) | - | 35/45/55 | RH-LH | Beavertail-Rounded |
| 694 Skeet | 12 | 76 | 74 | 10x8 | OCHP | 5 chokes | 35/50 | RH-LH | Rounded |
| 694 Skeet (B-Fast) | 12 | 76 | 74 | 10x8 | OCHP | 5 chokes | 35/55 | RH-LH | Rounded |
| 694 ACS (B-Fast) | 12 | 76 | 76-81 | 10x8 adjustable | OCHP | 5 chokes | 35/55 | RH-LH | Schnabel-Rounded |
| 694 DTL | 12 | 76 | 76 | 10x8 | OCHP | 5 chokes | 35/45 - 29/39 | RH-LH | Rounded |
| 694 DTL (B-Fast) | 12 | 76 | 76 | 10x8 | OCHP | 5 chokes | 35/45 | RH-LH | Rounded |
| 694 DTL Step Rib (B-Fast) | 12 | 76 | 76 | 10x8 step rib | OCHP | - | 40/40/58 | RH-LH | Beavertail |
| 694 Sporting Pro | 12 | 76 | 71-76-81 | 10x8 | OCHP | 5 chokes | 35/50 - 35/55 | RH-LH | Schnabel-Rounded |

DT II



DTII Skeet



DTII L Sporting Game Scene



DTII EELL Sporting Scroll

The most victorious shotgun ever. With DT11, balance, power and precision are in your hands, together with outstanding control and perfect trigger pull. The innovative Steelium Pro barrels ensuring great pattern and reduced muzzle raise, the detachable trigger, the wide receiver improving stability and ease of handling and the B-Fast adjusting devices make the DT11 the best competition over and under shotgun on the market.

| Model | Gauge | Chamber (mm) | Barrel (cm) | Rib (type) | Chokes (type) | Accessories | Drop (mm/mm) | Cast | Forend |
|-------------------------------------|-------|--------------|-------------|-----------------|---------------|-------------|--------------------------|-------|--------------------|
| DT11 Sporting | 12 | 76 | 71-76-81 | 10x8 | OCHP | 5 Chokes | 35/56-38/60-Headed | RH-LH | Schnabel-Rounded |
| DT11 Sporting (B-Fast) | 12 | 76 | 71-76-81 | 10x8 | OCHP | 5 Chokes | - | RH-LH | Schnabel-Rounded |
| DT11 Sporting Vittoria (B-Fast) | 12 | 76 | 71-76-81 | 10x8 | OCHP | 5 Chokes | 35/45/55 | RH-LH | Schnabel-Rounded |
| DT11 Skeet | 12 | 70 | 71-73 | 10x8 | OCHP | 5 Chokes | 35/56-38/60-Headed | RH-LH | Schnabel-Rounded |
| DT11 Skeet (B-Fast) | 12 | 70 | 71-73 | 10x8 | OCHP | 5 Chokes | - | RH-LH | Schnabel-Rounded |
| DT11 Trap | 12 | 70 | 75-76 | 10x10 | FX (**/)** | - | 29/39-32/42-34/44-Headed | RH-LH | Beavertail-Rounded |
| DT11 Trap (B-Fast) | 12 | 70 | 75-76 | 10x10 | FX (**/)** | - | - | RH-LH | Beavertail-Rounded |
| DT11 ACS (B-Fast) | 12 | 76 | 76-81 | 10x8 Adjustable | OCHP | 5 Chokes | Montecarlo Ad. | RH-LH | Schnabel-Rounded |
| DT11 XTrap (B-Fast) | 12 | 76 | 76-81 | Adjustable | OCHP | 5 Chokes | Montecarlo Ad. | RH-LH | Beavertail-Rounded |
| DT11 L Sporting Scroll | 12 | 76 | 71-76-81 | 10x8 | OCHP | 5 Chokes | 35/56-38/60-Headed | RH-LH | Schnabel-Rounded |
| DT11 L Sporting Scroll (B-Fast) | 12 | 76 | 71-76-81 | 10x8 | OCHP | 5 Chokes | - | RH-LH | Schnabel-Rounded |
| DT11 L Sporting Game scene | 12 | 76 | 71-76-81 | 10x8 | OCHP | 5 Chokes | 35/56-38/60-Headed | RH-LH | Schnabel-Rounded |
| DT11 L Sporting Game scene (B-Fast) | 12 | 76 | 71-76-81 | 10x8 | OCHP | 5 Chokes | - | RH-LH | Schnabel-Rounded |
| DT11 L Trap Scroll | 12 | 70 | 75-76 | 10x10 | FX (**/)** | - | 29/39-32/42-34/44-Headed | RH-LH | Beavertail-Rounded |
| DT11 L Trap Scroll (B-Fast) | 12 | 70 | 75-76 | 10x10 | FX (**/)** | - | - | RH-LH | Beavertail-Rounded |
| DT11 EELL Sporting | 12 | 76 | 71-76-81 | 10x8 | OCHP | 5 Chokes | 35/56 - 38/60 | RH-LH | Rounded |
| DT11 EELL Sporting | 12 | 76 | 71-76-81 | 10x8 | OCHP | 5 Chokes | Headed | RH | Rounded |
| DT11 EELL Sporting (B-Fast) | 12 | 76 | 71-76-81 | 10x8 | OCHP | 5 Chokes | - | RH-LH | Rounded |
| DT11 EELL Trap | 12 | 70 | 75-76 | 10x10 | FX (**/)** | - | 29/39-32/42 | RH-LH | Rounded |
| DT11 EELL Trap | 12 | 70 | 75-76 | 10x10 | FX (**/)** | - | Headed | RH | Rounded |
| DT11 EELL Trap (B-Fast) | 12 | 70 | 75-76 | 10x10 | FX (**/)** | - | - | RH-LH | Rounded |
| DT11 DTL (B-Fast) | 12 | 76 | 76 | 10x10 | OCHP | 5 Chokes | 35/45 | RH-LH | Rounded |

DT II BLACK EDITION



DT II Black Pro Sporting

DT II Black: the highest expression of the Beretta competition over and under, in a black and hyper-technological edition. Carbon fiber top rib, carbon fiber trigger plate and the most complete B-Fast ever, featuring both stock and barrel balancing system. The choice of champions, in Black Edition.

| Model | Gauge | Chamber (mm) | Barrel (cm) | Rib (type) | Chokes (type) | Accessories | Drop (mm/mm) | Cast | Forend |
|---------------------------------------|-------|--------------|-------------|--------------------|---------------|-------------|--------------------|----------------|------------------|
| DT II Black Pro Sporting | 12 | 76 | 81 | 10x10 Carbon fiber | OCHP | 5 Chokes | - | RH-LH - Size L | Rounded |
| DT II Black Pro Trap | 12 | 70 | 76 | 10x10 Carbon fiber | FX (**/*) | - | - | RH-LH - Size L | Rounded |
| DT II Black Pro Skeet | 12 | 70 | 76 | 10x10 Carbon fiber | OCHP | 5 Chokes | - | RH-LH - Size L | Rounded |
| DT II Black Edition Sporting | 12 | 76 | 76-81 | 10x10 Carbon fiber | OCHP | 5 Chokes | 35/56-38/60-Headed | RH-LH | Schnabel-Rounded |
| DT II Black Edition Sporting (B-Fast) | 12 | 76 | 76-81 | 10x10 Carbon fiber | OCHP | 5 Chokes | - | RH-LH | Schnabel-Rounded |
| DT II Black Edition Trap | 12 | 70 | 76-81 | 10x10 Carbon fiber | FX (**/*) | - | 32/42-Headed | RH-LH | Rounded |
| DT II Black Edition Trap (B-Fast) | 12 | 70 | 76-81 | 10x10 Carbon fiber | FX (**/*) | - | - | RH-LH | Rounded |
| DT II Black Edition Skeet | 12 | 70 | 76 | 10x10 Carbon fiber | OCHP | 5 Chokes | Headed | RH-LH | Rounded |
| DT II Black Edition Skeet (B-Fast) | 12 | 70 | 76 | 10x10 Carbon fiber | OCHP | 5 Chokes | - | RH-LH | Rounded |

DT11 Black Edition EELL Sporting

The EELL version of the DT11 Black Edition brings the use of carbon fiber to levels never reached before in the firearms world.

In addition to the top rib, the trigger plate, and the trigger group, the Beretta DT11 Black Edition EELL over and under shotgun also features carbon fiber trigger guard and two innovative long side plates, where the engraving reflects the characteristic carbon fiber twill texture.

The stock, made of selected grade 4 walnut wood, is available in an adjustable, fixed or headed version.

The oil finishing provides the wood with higher water resistance. The hand made 1 mm checkering gives the stock a more refined look and a firm and comfortable grip.

| Model | Gauge | Chamber (mm) | Barrel (cm) | Rib (type) | Chokes (type) | Accessories | Drop (mm/mm) | Cast | Forend |
|---|-------|--------------|-------------|--------------------|---------------|-------------|--------------|-------|---------|
| DT11 Black Edition EELL Sporting | 12 | 76 | 76-81 | 10x10 Carbon fiber | OCHP | 5 Chokes | 35/56-38/60 | RH-LH | Rounded |
| DT11 Black Edition EELL Sporting | 12 | 76 | 76-81 | 10x10 Carbon fiber | OCHP | 5 Chokes | Headed | RH-LH | Rounded |
| DT11 Black Edition EELL Sporting (B-Fast) | 12 | 76 | 76-81 | 10x10 Carbon fiber | OCHP | 5 Chokes | - | RH-LH | Rounded |
| DT11 Black Edition EELL Trap | 12 | 70 | 76 | 10x10 Carbon fiber | FX (**/*) | - | 29/39-32/42 | RH-LH | Rounded |
| DT11 Black Edition EELL Trap | 12 | 70 | 76 | 10x10 Carbon fiber | FX (**/*) | - | Headed | RH-LH | Rounded |
| DT11 Black Edition EELL Trap (B-Fast) | 12 | 70 | 76 | 10x10 Carbon fiber | FX (**/*) | - | - | RH-LH | Rounded |

10TH ANNIVERSARY

DT11

LIMITED EDITION



| Model | Gauge | Chamber (mm) | Barrel (cm) | Rib (type) | Chokes (type) | Accessories | Drop (mm/mm) | Cast | Forend |
|--|-------|--------------|-------------|------------|---------------|-------------|-----------------------|-------|---------|
| DT11 10 th Anniversary Trap | 12 | 70 | 75 | 10x10 | FX | - | 29/39 - 32/42 - 34/44 | RH-LH | Rounded |
| DT11 10 th Anniversary Skeet | 12 | 70 | 73 | 10x8 | OCHP | 5 chokes | 35/56 | RH-LH | Rounded |
| DT11 10 th Anniversary Sporting | 12 | 76 | 76-81 | 10x8 | OCHP | 5 chokes | 35/56 - 38/60 | RH-LH | Rounded |



10TH ANNIVERSARY
DT 11
LIMITED EDITION

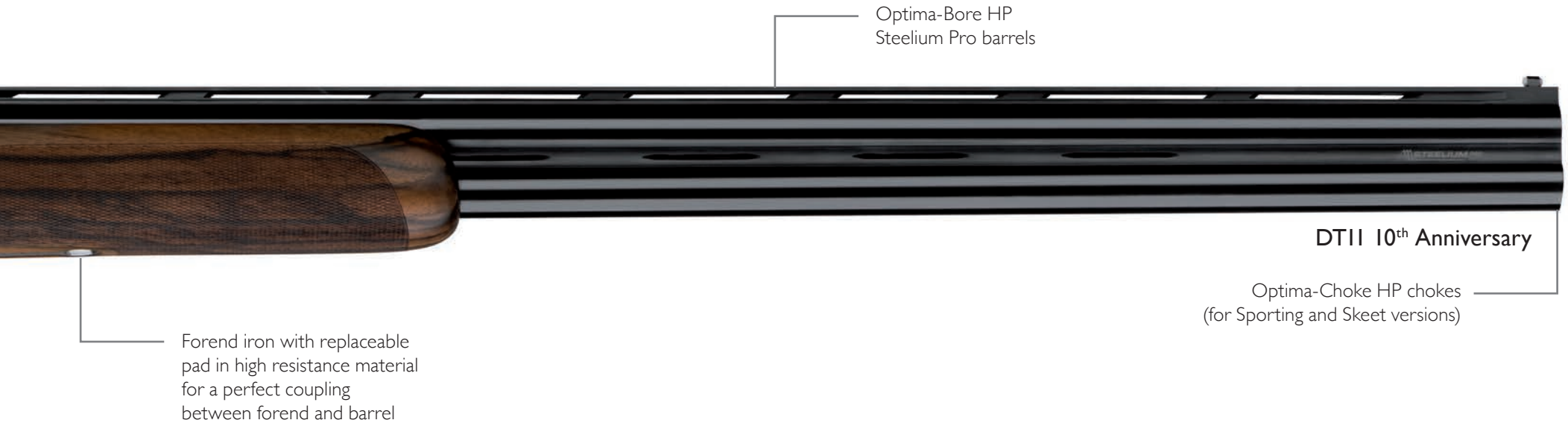

Forend iron with replaceable pad in high resistance material for a perfect coupling between forend and barrel

Optima-Bore HP
Steelium Pro barrels

DT11 10th Anniversary

Optima-Choke HP chokes
(for Sporting and Skeet versions)

There is no shooter in the world, from the inexperienced beginner to the expert champion, who is not aware of the outstanding precision, balance, handling, and durability of DT11 competition shotguns. To mark 10 years of success, achieved both internationally, in the professional arena, and by amateurs on shooting ranges all over the world, Beretta has created an Anniversary edition of the DT11. With all the outstanding features of the legendary DT11, the DT11 10th Anniversary has been redesigned in a commemorative guise, featuring meticulous engraving with a modern floral motif and hand polished, mirrored side plates. This model will be available in a limited run of just 350 pieces, divided between Trap, Skeet and Sporting versions.

A400 Xcel



Aqua Tech Shield coating
for superior corrosion resistance

New receiver top and bottom profile

Extended
bolt handle
and release

New competition shell carrier

Available with
Kick-Off Plus
wood stock:
-40% of felt recoil

New pistol grip design
with palm swell

| Model | Gauge | Chamber (mm) | Barrel (cm) | Rib (type) | Chokes (type) | Accessories | Pad |
|--|-------|--------------|-------------|--------------------|---------------|-------------------------------------|------------|
| A400 Xcel Sporting | 12 | 76 | 71-76-81 | 10x8 | OCHP | 3 Chokes Black Edition (**/**/****) | MicroCore® |
| A400 Xcel Sporting Kick-Off Plus | 12 | 76 | 71-76-81 | 10x8 | OCHP | 3 Chokes Black Edition (**/**/****) | MicroCore® |
| A400 Xcel Sporting Black | 12 | 76 | 71-76-81 | 10x10 carbon fiber | OCHP | 3 Chokes Black Edition (**/**/****) | MicroCore® |
| A400 Xcel Sporting Black Kick-Off Plus | 12 | 76 | 71-76-81 | 10x10 carbon fiber | OCHP | 3 Chokes Black Edition (**/**/****) | MicroCore® |
| A400 Xcel Sporting Vittoria | 12 | 76 | 71 | 10x8 | OCHP | 3 Chokes Black Edition (**/**/****) | MicroCore® |

A400
Xcel



New top rib competition design

New forend
and ergonomics

New shooting cap design
with aftermarket weights for gun balance

A400 Xcel Sporting

3 OCHP Black edition 20mm ext. Chokes

The fastest, lowest-recoil clay buster. Built on the revolutionary A400 action, the newest iteration of the Beretta A400 Xcel Sporting features enlarged controls, the innovative B-Link gas operating system for 36% faster follow-up shots, and Beretta's Kick-Off Plus recoil reduction system for enhanced stability, comfort, control and faster target acquisition. Quickly becoming a favorite among competitive shooters, its sleek lines and superior ergonomics are designed with one goal in mind: naturally following your eye to the target.



686 Silver Pigeon I Sporting Vittoria (B-Fast)



686 Silver Pigeon I Sporting Vittoria (B-Fast)

| Model | Gauge | Chamber (mm) | Barrel (cm) | Rib (type) | Chokes (type) | Accessories | Drop (mm/mm) | Cast | Forend |
|--|-------|--------------|-------------|------------|---------------|-------------|--------------|-------|----------|
| 686 Silver Pigeon I Sporting Vittoria | 12 | 76 | 71-76-81 | 10x8 | OCHP | 5 Chokes | 35/45/55 | RH-LH | Schnabel |
| 686 Silver Pigeon I Sporting Vittoria (B-Fast) | 12 | 76 | 76 | 10x8 | OCHP | 5 Chokes | 35/45/55 | RH-LH | Schnabel |
| 686 Silver Pigeon I Sporting Vittoria | 20 | 76 | 76 | 8x8 | OCHP | 5 Chokes | 35/45/55 | RH-LH | Schnabel |
| 687 Silver Pigeon III Sporting Vittoria (B-Fast) | 12 | 76 | 71-76-81 | 10x8 | OCHP | 5 Chokes | 35/45/55 | RH-LH | Schnabel |
| 687 Silver Pigeon III Sporting Vittoria (B-Fast) | 20 | 76 | 76 | 8x8 | OCHP | 5 Chokes | 35/45/55 | RH-LH | Schnabel |

694 Sporting Vittoria (B-Fast)

The Vittoria series is the first Beretta's shotgun range specifically designed for women. Vittoria shotguns feature a dedicated ergonomics, suited to those with a shorter stature, to ensure a smooth, comfortable and precise handling. These guns are fitted with a shortened, semi-Montecarlo style stock, have a reduced pistol grip and additionally are completed by a 1 mm checkering, derived from the premium guns, beneficial for smaller hands.

| Model | Gauge | Chamber (mm) | Barrel (cm) | Rib (type) | Chokes (type) | Accessories | Drop (mm/mm) | Cast | Forend |
|----------------------------------|-------|--------------|-------------|------------|---------------|------------------------|--------------|-------|--------------------|
| 694 Sporting Vittoria (B-Fast) | 12 | 76 | 71-76-81 | 10x8 | OCHP | 5 Chokes, Extended | 35/45/55 | RH-LH | Schnabel-Rounded |
| 694 Trap Vittoria (B-Fast) | 12 | 76 | 76-81 | 10x10 | FX (**/*) | - | 35/45/55 | RH-LH | Beavertail-Rounded |
| DT II Sporting Vittoria (B-Fast) | 12 | 76 | 71-76-81 | 10x8 | OCHP | 5 Chokes | 35/45/55 | RH-LH | Schnabel-Rounded |
| A400 Xcel Sporting Vittoria | 12 | 76 | 71 | 10x8 | OCHP | 5 Chokes Black Edition | 35/45/55 | RH-LH | - |

1301 Comp



1301 Comp

The Beretta 1301 Comp semiauto shotgun is designed to win tactical competitions right out of the box. Combining the technology of Beretta's best sporting shotguns with the requirements of the most demanding tactical shooters, it cycles faster than the other competition shotguns, handles like a dream and has oversized controls for super-easy operation.

It is available in two barrel lengths (53,5 and 61 cm) and its receiver is drilled and tapered for rail mounts, so that it can be equipped with optics or tactical aiming devices without any gunsmithing. And thanks to its Optima-Choke HP interchangeable choke system, it can also be adapted for other uses and will always perform like a Beretta.

| Model | Gauge | Chamber (mm) | Barrel (cm) | Rib (type) | Chokes (type) | Accessories | Pad |
|-----------|-------|--------------|-------------|----------------|---------------|-------------------------------|--------|
| 1301 Comp | 12 | 76 | 53,5 - 61 | 10x8 with step | OCHP | 1 Choke (****/IC) - Extension | Rubber |

1301 Comp PRO



1301 Comp Pro

After gaining the podiums of the Shotgun World Championships with its incomparable cycling speed, the 1301 Comp evolves in the Pro version, incorporating the improvements suggested by the multi-rated Beretta shooters. With the comfort, stability and ease of shouldering of its stock, its super-fast, safe and easy loading system, the enlarged bolt release button and bolt handle and the Beretta by Tony System extended magazine for 10 + 1 cartridges, the 1301 Comp Pro is today the most competitive platform for practical shooting, already in its out-of-the-box configuration, yet allowing further personalization, so sought after by the most demanding shooters.

| Model | Gauge | Chamber (mm) | Barrel (cm) | Rib (type) | Chokes (type) | Accessories | Cast | Pad |
|---------------|-------|--------------|-------------|----------------|---------------|--|-------|------------|
| 1301 Comp Pro | 12 | 76 | 53,5 - 61 | 10x8 with step | OCHP | 3 Chokes Black Edition (**/****/*****) | RH-LH | MicroCore® |

92X PERFORMANCE



The 92X Performance: accuracy, power and speed the #1 choice of champions way. The new Beretta handgun specifically designed for competition does not accept compromises and aims to top performances, by bringing on the shooting ranges one of the most reliable locking systems ever, along with a full steel vertec frame, a heavier Brigadier slide and the new surprisingly fast and crisp Extreme-S trigger mechanism. The 92X Performance is now available in the Defensive version, lightened, modified and now approved for IDPA and USPSA competitions and in the Optic version, red dot ready.

| Model | Gauge | Action | Additional Magazines | Magazine Capacity (rounds) | Weight Unloaded (g) | Total Length (mm) | Barrel Length (mm) | Width (mm) | Height (mm) | Safety Position | Grips |
|----------------------------|-------|--------|----------------------|----------------------------|---------------------|-------------------|--------------------|------------|-------------|-----------------|---------|
| 92X Performance Production | 9x19 | S - D | 1 | 15 | 1350 | 222 | 125 | 48 | 148 | Frame | Plastic |
| 92X Performance Defensive | 9x19 | S - D | 1 | 10 | 1210 | 222 | 125 | 41 | 148 | Frame | Plastic |
| 92X Performance Optic | 9x19 | S - D | 1 | 15 | 1350 | 222 | 125 | 48 | 148 | Frame | Plastic |

Triggers



Magazines



Safety



Red dot kits



Holsters and mag pouches



Grips



Spare parts and conversion kits



Magwells and mag extensions



Gel bumpers



Speedloaders



Cleaning kits



Hard and soft cases



Merchandise



Beretta 92X Performance comes with a wide range of accessories to take your shooting experience to its full potential. Complete your pistol with Beretta products and live your passion to the fullest.

IN 1915 BERETTA LAUNCHED
ITS FIRST SEMI-AUTO PISTOL.
DIFFERENT GENERATIONS OF BERETTA HANDGUNS
HAVE GONE THROUGH ALL THE GREAT CHALLENGES
OF THE LAST CENTURY.
TODAY, WITH MORE THAN A HUNDRED YEARS
OF EXPERIENCE IN THE FIELD, THE NEW PLATFORMS
ARE BORN WITH A CLEAR AWARENESS
OF THE NEEDS OF TACTICAL AND COMPETITION USERS
AND WITH CONSTANT ATTENTION
TO THE NEW FRONTIERS OF INNOVATION.

BERETTA TACTICAL PRODUCTS
ARE DEVELOPED, TESTED, AND BUILT
FOR THOSE WHO COME PREPARED TO WIN.
TRAIN WITH PASSION TO

#WINTHEFIGHT



TRAIN
— WITH —
PASSION

90 Series



92 FS

| Model | Gauge | Action | Additional Magazines | Magazine Capacity (rounds) | Weight Unloaded (g) | Total Length (mm) | Barrel Length (mm) | Width (mm) | Height (mm) | Safety Position | Grips |
|--------------|-------|--------|----------------------|----------------------------|---------------------|-------------------|--------------------|------------|-------------|-----------------|---------|
| 92 FS | 9x19 | S - D | 1 | 15 | 945 | 217 | 125 | 38 | 143 | Slide | Plastic |
| 92 FS Inox | 9x19 | S - D | 1 | 15 | 945 | 217 | 125 | 38 | 143 | Slide | Rubber |
| 92 AI | 9x19 | S - D | 1 | 15 | 945 | 217 | 125 | 38 | 143 | Slide | Plastic |
| 92 FS Grey | 9x19 | S - D | 1 | 15 | 945 | 217 | 125 | 38 | 143 | Slide | Plastic |
| 92 FS Bronze | 9x19 | S - D | 1 | 15 | 945 | 217 | 125 | 38 | 143 | Slide | Plastic |

90 Series



92 FS Grey



92 FS Bronze

The Beretta 92 has been setting the standards for best military, police and tactical pistol for over a quarter century.

The reason is that it was designed, and has kept evolving to be and remain the most accurate, durable and reliable semi-auto handgun on the market. Easy to use, absolutely safe and delivering impressive firepower, it remains the sidearm of allied forces the world over, as well as of countless police and law-enforcement agencies.

Px4



Px4 Storm
Inox



Px4 Storm
Special Duty



Px4 Storm
Compact



Px4 Storm
Compact Inox





Px4 Storm

Absolute durability, reliability, and ergonomics have made it the go-to choice for shooters around the world. Designed to meet the most stringent military standards of durability, the PX4 has been reported to fire well over 150,000 rounds with zero part breakage. The lines of the pistol are snag-free and make unholstering and reholstering easy and fluid. The pistol may be adapted to different hand sizes and shooting styles thanks to a modular design with interchangeable backstraps. The ambidextrous and reversible controls offer the possibility to easily train or shoot with either hand. Besides being one of the strongest actions available, the rotary barrel dissipates recoil away from the shooter's hand and greatly reduces muzzle jump, making it an extremely fast and accurate. Disassembly is designed to allow for quick field stripping.

| Model | Gauge | Action | Additional Magazines | Magazine Capacity (rounds) | Weight Unloaded (g) | Total Length (mm) | Barrel Length (mm) | Width (mm) | Height (mm) | Safety Position | Grips |
|--------------------------|---------|--------|----------------------|----------------------------|---------------------|-------------------|--------------------|------------|-------------|-----------------|-----------------|
| PX4 Storm Type F | 9x19 | S - D | 1 | 17 | 785 | 192 | 102 | 36 | 140 | Slide | Int. backstraps |
| PX4 Storm Type G | 9x19 | S - D | 1 | 17 | 785 | 192 | 102 | 36 | 140 | LAC | Int. backstraps |
| PX4 Storm Inox | 9x19 | S - D | 1 | 17 | 785 | 195 | 102 | 36 | 140 | Slide | Int. backstraps |
| PX4 Storm Compact Type F | 9x19 | S - D | 1 | 15 | 770 | 173 | 83 | 36 | 129 | Slide | Int. backstraps |
| PX4 Storm Compact Inox | 9x19 | S - D | 1 | 15 | 770 | 173 | 83 | 36 | 129 | Slide | Int. backstraps |
| PX4 Storm Type F | .40 S&W | S - D | 1 | 14 | 810 | 192 | 102 | 36 | 140 | Slide | Int. backstraps |
| PX4 Storm Type G | .40 S&W | S - D | 1 | 14 | 810 | 192 | 102 | 36 | 140 | LAC | Int. backstraps |
| PX4 Storm Inox | .40 S&W | S - D | 1 | 14 | 785 | 192 | 102 | 36 | 140 | Slide | Int. backstraps |
| PX4 Storm Compact Type F | .40 S&W | S - D | 1 | 12 | 770 | 173 | 83 | 36 | 129 | Slide | Int. backstraps |
| PX4 Storm Type F | 45 ACP | S - D | 1 | 9-10 | 800 | 195 | 102 | 36 | 140 | Slide | Int. backstraps |
| PX4 Storm Special Duty * | 45 ACP | S - D | 2 | 9-10 | 820 | 210 | 115 | 36 | 145 | Slide | Int. backstraps |



APX^{A1}

Aqua Tech Shield coating for added corrosion and wear resistance

RDO ready with removable cover



Improved slide with aggressive serrations for sure racking in all conditions

APX A1

Enhanced ergonomics deliver consistent grip and superb control

Crisp, clean-breaking trigger with shorter, lighter pull and tactile reset



APX^{A1}



APX A1

The Beretta APX A1 encompasses the reliability and quality the APX family has become known for within the shooting communities. Years of extensive training and real-world use converge in a handgun designed and built for performance and maximum resistance. With a shorter and lighter trigger pull and tactile reset, the improved slide with aggressive serrations, the enhanced grip and its endless opportunities for RDO mount and further customization, the APX A1 creates ease of use for a wide range of end-users.

| Model | Gauge | Action | Additional Magazines | Magazine Capacity (rounds) | Weight Unloaded (g) | Total Length (mm) | Barrel Length (mm) | Width (mm) | Height (mm) | Safety Position | Grips |
|--------|-------|---------|----------------------|----------------------------|---------------------|-------------------|--------------------|------------|-------------|-----------------|-----------------|
| APX A1 | 9x19 | Striker | 1 | 17 | 822 | 190 | 108 | 33 | 140 | Trigger | Int. backstraps |



BERETTA
APX
MADE IN ITALY

BERETTA

BERETTA

Magwells and mag pads



Magazines



Safety



Red dot kits



Holsters and mag pouches



Lights



Backstraps



Spare parts and conversion kits



Gel bumpers



Speedloaders



Cleaning kits



Hard and soft cases



Merchandise



Inert training tools



Beretta APX A1 comes with a wide range of accessories to take your shooting experience to its full potential. Complete your pistol with Beretta products and live your passion to the fullest.

1301 TACTICAL



I301 Tactical



I301 Tactical FDE

| Model | Gauge | Chamber (mm) | Barrel (cm) | Sights (mm) | Chokes (type) | Accessories | Pad |
|-----------------------------|-------|--------------|-------------|-------------|---------------|---------------|------------|
| I301 Tactical | 12 | 76 | 47,5 | Ghost Ring | OCHP (CL) | Stock spacers | MicroCore® |
| I301 Tactical FDE | 12 | 76 | 47,5 | Ghost Ring | OCHP (CL) | Stock spacers | MicroCore® |
| I301 Tactical OD Green | 12 | 76 | 47,5 | Ghost Ring | OCHP (CL) | Stock spacers | MicroCore® |
| I301 Tactical Inox / Marine | 12 | 76 | 47,5 | Ghost Ring | OCHP (CL) | Stock spacers | MicroCore® |

1301 TACTICAL



I301 Tactical OD Green



I301 Tactical Inox / Marine

The I301 is Beretta's gas operated semi-automatic shotgun engineered to be ultra-reliable and easy to use. Thanks to its compact size, it is ideal for negotiating tight spaces. It has all the features that a modern tactical shotgun should offer and it is easily adaptable to most users' needs, body type and shooting posture. Right out-of-the-box, the I301 Tactical features an oversized charging handle, large textured bolt release and an oversized reversible safety button. The integrated B-Link gas operating system, featuring a cross tube gas piston, allows the I301 Tactical to cycle 36% faster than any other shotgun on the market. This also makes it ideal for 3-gun competitions.

CX4 Storm



Cx4 Storm

| Model | Gauge | Action | Additional Magazines | Magazine Capacity | Weight Unloaded | Total length (mm) | Barrel length (mm) | Width | Height | Safety Position |
|---------------|-------|--------|----------------------|-------------------|-----------------|-------------------|--------------------|-------|--------|-----------------|
| Cx4 Storm FDE | 9X19 | S | 1 | 10-15 | 2575 | 755 | 422,5 | 63 | 190 | Slide |
| Cx4 Storm | 9X19 | S | 1 | 10-15 | 2575 | 755 | 422,5 | 63 | 190 | Slide |

CX4 Storm



Cx4 Storm FDE

The Cx4 is a semiauto pistol-caliber carbine designed to give you the familiar controls of your favorite Beretta combat handgun. The operating handle, safety and magazine release are reversible and give you the opportunity to train or shoot right- or left-handed, while case ejection can also be switched from right to left. The length of pull is adjustable. Sights, lighting and other accessories can be easily mounted, thanks to the top rail, the retractable Picatinny rail and possibility to mount additional rails on the left, right and bottom. And after a day at the range, this carbine is a snap to take apart and reassemble, while its ultra-tough construction and surface treatment make it stand up to the hardest use.

BERETTA KICK-OFF SYSTEM

WORLD'S BEST RECOIL AND MUZZLE RISE REDUCTION

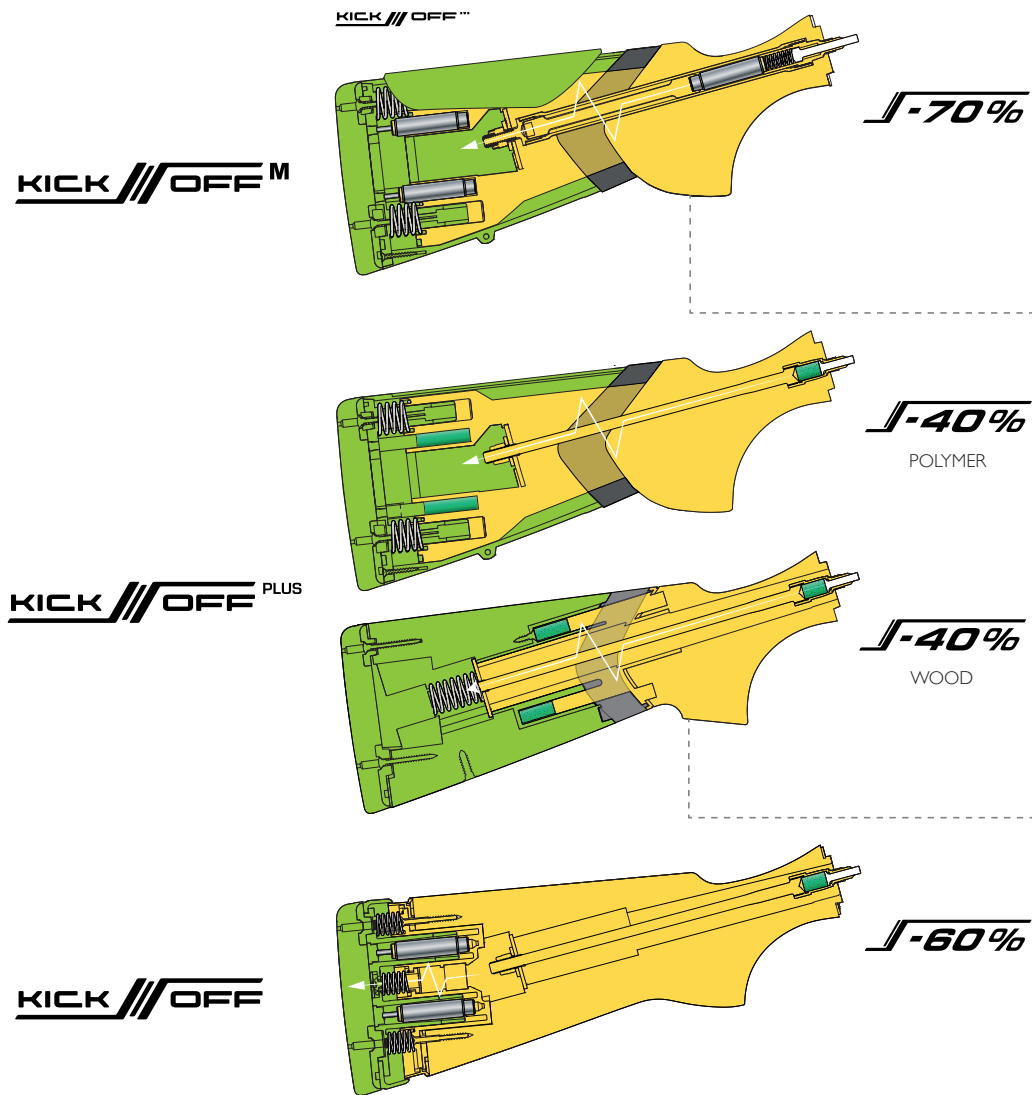

Kick-Off Mega is the most powerful recoil reduction system available today, ideal for 89 mm chambered shotguns, especially when you enjoy shooting high loads and hundreds of shots in a single day. It effectively combines 3 different devices that work synergistically, reducing the perceived recoil by up to 70%, ensuring greater stability, better control and faster target acquisition. Two hydraulic shock absorbers, similar to those used in the automotive and aerospace industry, positioned close to the rubber insert, together with return springs, effectively act on the first recoil peak. A third hydraulic shock absorber, inserted in the tie rod, acts on the second recoil peak caused by the impact of the slide against the receiver, further reducing the muzzle rise effect and the vibrations caused by the movement of the slide.

Kick-Off Plus consists of two elastomer shock absorbers, positioned close to the rubber insert and equipped with return springs, which effectively act on the first recoil peak, reducing its perception up to 40%. A third elastomer shock absorber, inserted in the tie rod, absorbs the impact of the slide against the receiver, reducing the second recoil peak, the muzzle rise effect and the vibrations caused by the movement of the slide.

Kick-Off is the first recoil reduction system developed by Beretta using hydraulic shock absorbers similar to those used in the automotive and aeronautical industries. It consists of two shock absorbers inserted close to the butt plate, completed by return springs, which effectively act on the first recoil peak, reducing the perceived recoil up to 60%. A third elastomer shock absorber, inserted in the tie rod, acts on the second recoil peak caused by the impact of the slide against the receiver, further reducing the muzzle rise effect and the vibrations caused by the movement of the slide.

The **B-Steady** system divides the stock into two sections: stock and pistol. The point of absorption of the recoil is in an advanced position, integral with the pistol, which is free to move back, leaving the stock stable and avoiding the annoying sliding of the nose piece on the cheek. The face remains firm and perfectly steady on the stock, without ever losing the line of sight.



STEELIUM BARREL

THE BEST BALLISTIC PERFORMANCE ON THE MARKET

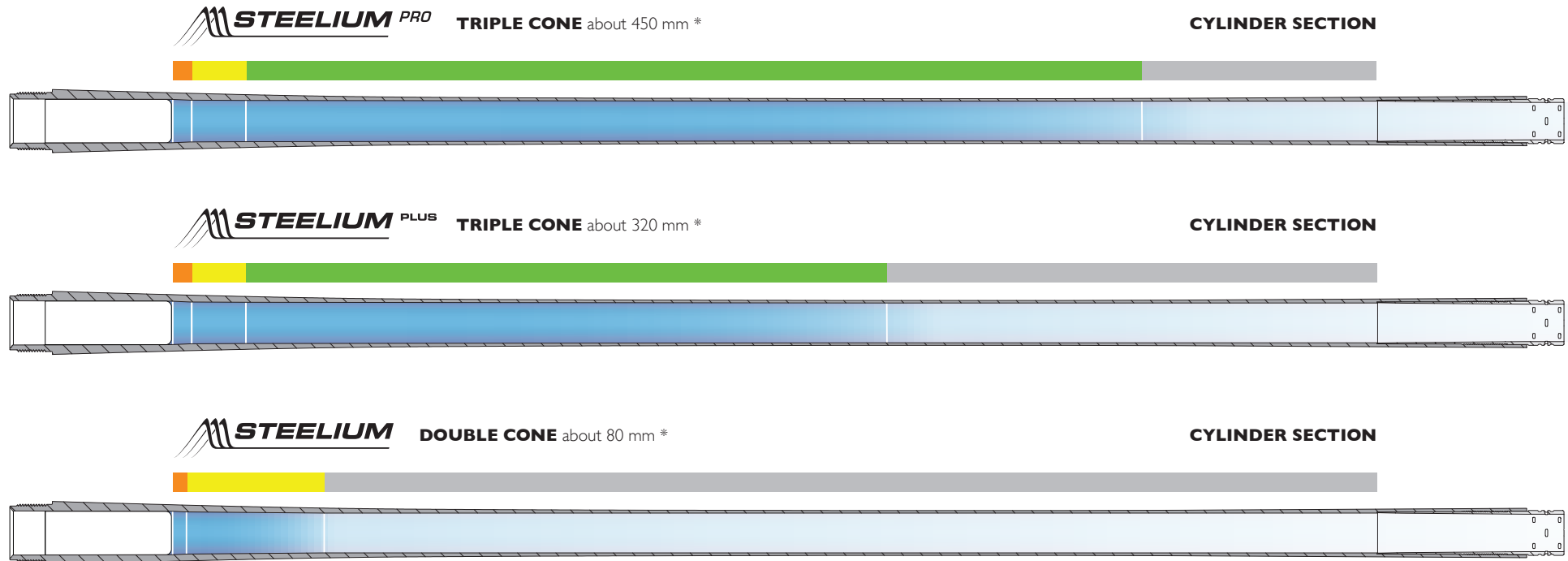

The ingredients for the stunning performance of the Beretta **Steelium barrels** are: the exclusive tri-alloy Beretta steel (Ni, Cr, Mo), the deep drilling, the cold hammer forging, the vacuum distension and the 80 mm extended forcing cone. The inner profile of the Optima-Bore HP barrels has been designed and tested to provide perfect accuracy with every type of shells: lead, steel and High Performance steel. This results in perfect patterns on every shot.

The **Steelium Plus** barrels have a triple forcing cone that reaches a length of 320 mm (in a 76 cm barrel). In **Steelium Pro** barrels, the length of the forcing cone is further extended, up to 450 mm (in 76 cm barrels). This progressive inner profile of the barrel provides smoother shot with reduced muzzle rise and guarantees perfect, dense and uniform patterns with any type of ammunition.

* The indicated lengths are based on 76 cm barrels.

LEGAL NOTES: while every effort has been made to make this catalog as complete and accurate as possible, changes may occur at any time in the illustrations, descriptions, colors shown, and technical specs listed. Beretta provides ongoing improvements to its products and consequently, all specifications can vary without notice.

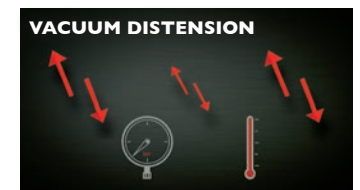





THE OFFICIAL BERETTA FIREARM ASSISTANCE

In Beretta, the maintenance of your firearm is carried out by a professional Beretta gunsmith, a member of the same team who gave life to your gun. Our know-how, the use of the last generation equipment, authentic spare parts and accessories ensure the best possible care for your Beretta firearm. Today our gunsmiths are able to provide you the best service on:

- Barrel maintenance and treatment
- Wood making and treatment
- Mechanical parts maintenance, repair and replacement and much more.

Contact your local Beretta dealer to receive assistance on your firearm.







**GOT A NEW BERETTA FIREARM?
EXTEND YOUR WARRANTY!**

Register your firearm on registeryour.beretta.com and extend your warranty from 2 to 3 years*.
Enter Beretta community and discover a new world of benefits.

Registration is due within 30 days from purchase. Terms and conditions: beretta.com/en/garanzia-del-fabbricante

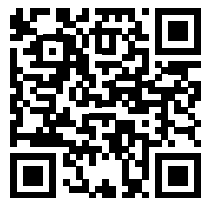
*Some countries may apply enhanced warranty conditions, please verify with your local distributor.





BERETTA DIGITAL USER MANUALS: ALL THE TIPS YOU NEED, ALWAYS AT YOUR FINGERTIPS

With just a click, you can access the user manual for your Beretta firearm right from your smartphone, find all the info you need, and go on with your adventure straight-away!

The new Beretta digital user manuals are:

- Always accessible wherever you are
- Easy to navigate and search
- Available with additional support capabilities, including HOW-TO videos showing you how your firearm works and how you can take care of it.
- Always updated

Find your manual on:

USERMANUAL.BERETTA.COM



BERETTA GALLERY

LONDON

36 St. James's Street
London SW1A 1JD, U.K.
Tel. +44 207 408 4411

PARIS

57, Rue Pierre Charron
75008 Paris, France
Tel. +33 1 56 88 59 59

NEW YORK

718 Madison Avenue
New York, NY 10065, U.S.A.
Tel. +1 212 319 3235

DALLAS

41 Highland Park Village
Dallas, TX 75205, U.S.A.
Tel. +1 214 559 9800

BUENOS AIRES

Arenales 1654/56
C1061AAT CABA, Argentina
Tel. +54 114 8139 258

LONDON

Beretta at HARRODS
87-135 Brompton Road
London, SW1X 7XL, U.K.
Tel. +44 207 730 1234 ext. 2092

MILANO

Beretta at RAVIZZA
Via Hoepli, 3
20122 Milano, Italia
Tel. +39 02 7602 8325

MOSCOW

Beretta at KOLCHUGA
Varvarka str. 3
109012, Moscow, Russia
Tel. +8 495 234 34 43

MADRID

Beretta at EL CORTE INGLÉS
Raimundo Fernández de Villaverde, 79
28003 Madrid, España
Tel. +34 914 18 88 00

MEMPHIS

Beretta at BASS PRO SHOPS
1 Bass Pro Drive
Memphis Pyramid, TN 38105, U.S.A.
Tel. +1 901-291-8200